

MINI EXCAVATORS SK50P

Bucket capacity: 0.14 m³
 Engine Power: 29.6 kW at 2,400 min⁻¹
 Operating Mass: 4,720 kg



SPECIFICATIONS

MODEL		SK50P	
Type		SK50P-6	
Operating Mass / Canopy	kg	4,720	
Bucket Capacity	m ³ (ISO7451)	0.14	
Bucket Width (with side cutter)	mm	560 (600)	
Arm Length	m	1.40	
Bucket Digging Force	kN(kgf) (ISO7451)	35.2 (3,589)	
Arm Crowding Force	kN(kgf) (ISO7451)	28.0 (2,855)	
Drawbar Pulling Force	kN (SAE J1309 MAY91)	55.1	
ENGINE			
Model	YANMAR 4TNV88-B		
Type	Water-cooled, 4 cycle, 4 cylinder direct injection type diesel engine		
Power Output	kW/min ⁻¹ (ISO14396)	Net 29.6/2,400	
Max. Torque	N-m/min ⁻¹ (ISO14396)	Net 132.9/1,440	
Power Output	kw/min ⁻¹ (ISO9249)	Net 28.3/2,400	
Max. Torque	N-m/min ⁻¹ (ISO9249)	Net 131.1/1,440	
Displacement	mL	2,189	
Fuel Tank	L	75	
HYDRAULIC SYSTEM			
Type	Tandem variable displacement piston pumps		
Max. Flow	L/min	2 × 49.9	
Relief Valve Setting	MPa (kgf/cm ²)	23.0 (235)	
Hydraulic Oil Tank (System)	L	27.9 (57.7)	

TRAVEL SYSTEM			
Hydraulic Motor	2 × axial piston type		
Travel Brake	Hydraulic brake per motor		
Parking Brake	Oil disk brake per motor		
Travel Speed (High/Low)	km/h	3.7/2.1	
CRAWLER			
Shoe Width	mm	400	
Ground Pressure	Canopy	kPa (lbf/cm ²)	27.4 (0.28)
BLADE			
Width × Height	mm	1,960 × 345	
Working Ranges (Height : Depth)	mm	375 × 385	
SWING SYSTEM			
Hydraulic Motor	1 × axial piston type		
Swing Brake	Hydraulic brake		
Parking Brake	Oil disk brake, hydraulic operated automatically		
Swing Speed	min ⁻¹ (rpm)	8.8 (8.8)	
Tail Swing Radius	mm	1,170	
Min. Front Swing Radius	Over the front	mm	2,220
	Over the front at full boom swing	mm	1,850
SIDE DIGGING MECHANISM			
Type	Boom swing		
Offset Angle	degree	70/59	

WORKING RANGE & DIMENSIONS

SK50P

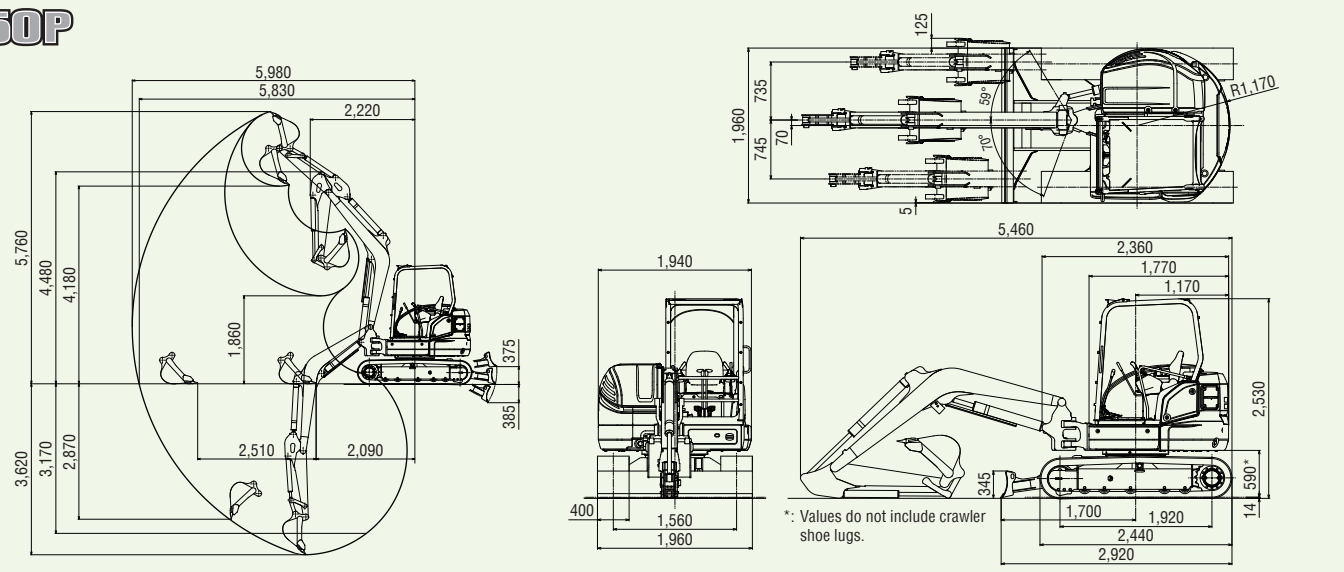

LIFTING CAPACITIES

Canopy Specification

SK50P-6		2.0 m		3.0 m		4.0 m		5.0 m		At max. reach		Radius
B		A		A		A		A		A		
4.0 m	kg			1,150*	1,140	800	690			740	650	4.14 m
3.0 m	kg					790	690			560	490	4.79 m
2.0 m	kg			1,220	1,040	760	650	510	440	490	420	5.11 m
1.0 m	kg			1,110	940	710	610	490	420	460	400	5.18 m
G. L.	kg			1,080	910	690	590	480	420	480	420	5.00 m
-1.0 m	kg	2,310	1,860	1,090	920	690	590			560	490	4.56 m
-2.0 m	kg	2,380	1,920	1,130	950					810	690	3.71 m

- Notes:**
- Do not attempt to lift or hold any load that is greater than these lift capacities at their specified lift point radius and height. Weight of all accessories must be deducted from the above lift capacities.
 - Lift capacities are based on machine standing on level, firm, and uniform ground. User must make allowance for job conditions such as soft or uneven ground out of level conditions, side loads, sudden stopping of loads, hazardous conditions, experience of personnel, etc.
 - Bucket lift hook is defined as lift point.
 - The above lift capacities are in compliance with SAE J1506. They do not exceed 87% of hydraulic lift capacity or 75% of tipping load. Lift capacities marked with an asterisk (*) are limited by hydraulic capacity rather than tipping load.
 - Operator should be fully acquainted with the Operator's and Maintenance instructions before operating this machine and rules for safe operation of equipment should be adhered to at all times.
 - Lift capacities apply to only machine as originally manufactured and normally equipped by KOBELCO CONSTRUCTION MACHINERY CO., LTD.

Note: This catalog may contain attachments and optional equipment that are not available in your area. And it may contain photographs of machines with specifications that differ from those of machines sold in your areas. Please consult your nearest KOBELCO distributor for those items you require. Due to our policy of continuous product improvements all designs and specifications are subject to change without advance notice. Copyright by KOBELCO CONSTRUCTION MACHINERY CO., LTD. No part of this catalog may reproduce in any manner without notice.

KOBELCO CONSTRUCTION MACHINERY CO., LTD.

17-1, Higashigotanda 2-chome, Shinagawa-ku, Tokyo 141-8626 JAPAN
 Tel: +81 (0) 3-5789-2146 Fax: +81 (0) 3-5789-2135
www.kobelco-kenki.co.jp/english_index.html

KOBELCO is the corporate mark used by Kobe Steel on a variety of products and in the names of a number of Kobe Steel Group companies.

Inquiries To:

SK50P-6-201-140403TF

OIL PALM EXPERT

With a thorough knowledge of palm plantations, KOBELCO has newly developed SK50P having further improved durability. The exclusive feature for palm plantations has been enhanced and expanded based on experience and know-how gained through the development of two models since SK40SR.



iNDr Cooling System

The revolutionary integrated dust reduction cooling system

The iNDr filter fitted in front of the cooling system ensures easy cleaning. The iNDr system on the SK50P features air intake at the front of the machine and air exhaust underneath. It functions in the same way as the iNDr System on the SR series machines.

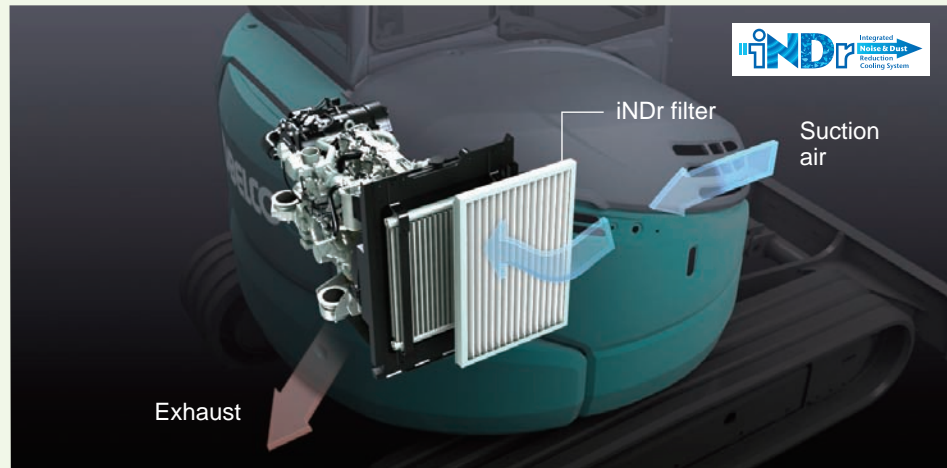

Visual checking and easy cleaning

Because the iNDr filter removes dust from the intake air, cooling components stay dirt-free and do not require regular cleaning. The iNDr filter itself can be easily removed and cleaned without the use of tools.



iNDr filter

The stainless-steel filter is extremely effective against dust, with 30-mesh wave-type screen that removes tiny dust particles from the intake air.

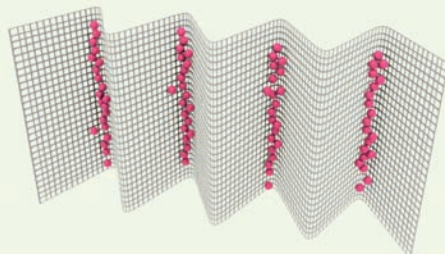

30-mesh means that there are 30 holes formed by horizontal and vertical wires in every square inch of filter.

iNDr filter blocks out dust

Outside air goes directly from the intake duct through the iNDr filter for dust removal.



Reliable Construction

RELIABILITY

The boom, arm and swing bracket all have large cross-section segments for added attachment strength. This is complemented by a high-strength power line and enhanced cooling function for ever more solid power.

Guard for tropical areas

This guard is designed to allow a large air intake port.

Cabin structure

The high-strength cab meets all three TOPS, ROPS, and FOPS Level I standards for greater operator safety. (ROPS:ISO3471 / TOPS: ISO12117 / FOPS ISO:10262). The four-pillar canopy ensures plenty of space enabling the operator to work comfortably.

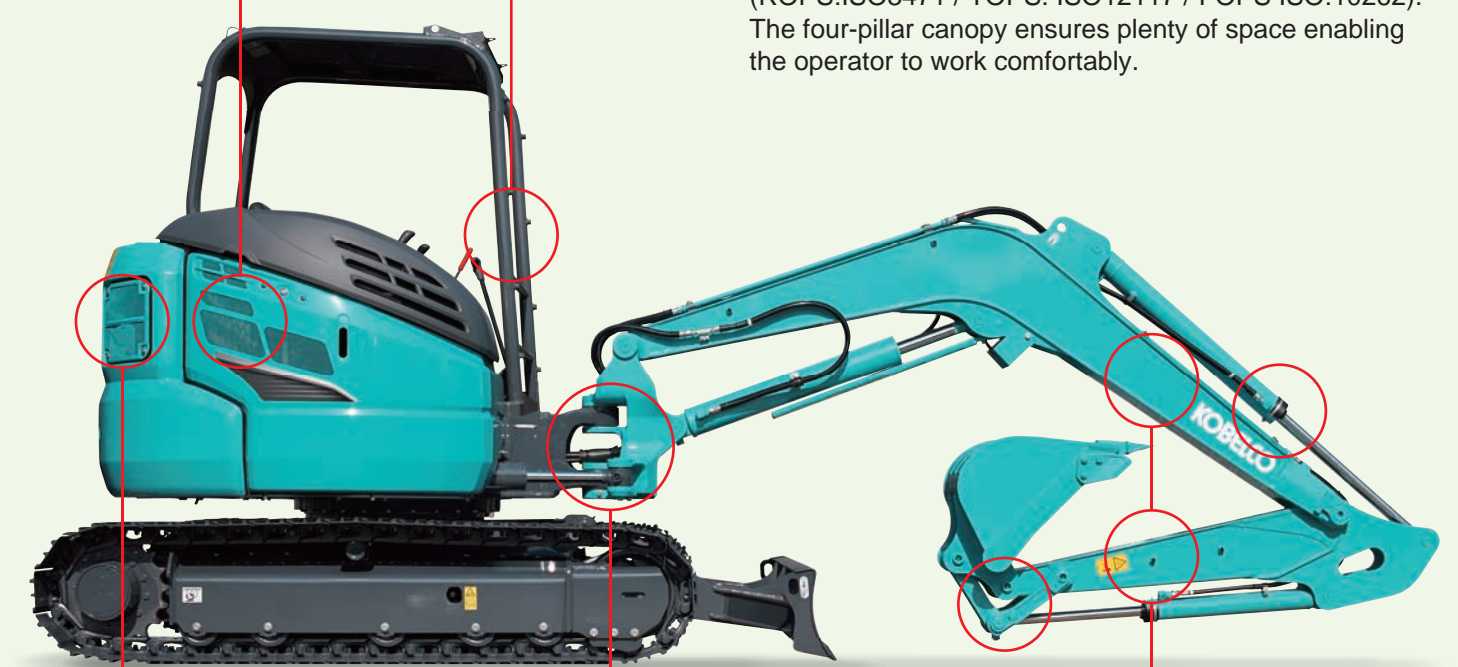

Large radiator

The high performance radiator with a wide heat exchange area has excellent cooling performance to operate the high-output engine at its best.

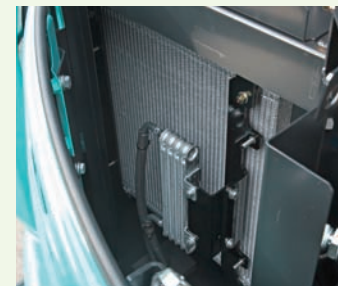

Swing bracket

Large, thick cast-iron swing bracket/front bracket.



Reinforced boom and arm

A reinforced arm is fitted as standard. High-grade steel, which combines less weight with greater bending strength, is used.

As with the arm, the boom has increased bending strength in the longitudinal direction though having the largest cross section area in the class. Under tough working conditions using a nibbler etc., it prevents cracking and other damage to the boom and arm over long working periods, and helps maintain a good price in the used machine market.

Bucket link

Cast-iron idler link provide greater strength.



Fuel filter

The main fuel filter and pre-filter prevent engine problems due to fuel contamination.



Dust seal protective cover

The standard feature of the protective cover guards the dust seals (for the bucket and arm) from the edges of hard palm tree leaves.



Overheat prevention alarm

This newly installed alarm warns operator of rise in radiator temperature, to eliminate risk of overheating.

Compact, yet, Big Performance

PERFORMANCE

Combination of wide working range and compact body ensures big performance for the palm work

The powerful travel torque and dozing performance with enhanced excellent fuel economy can provide significant benefits to palm plantations.

Powerful digging

Digging silt pits is an essential part of work to increase the palm harvest. The high-power engine gives the operator the feel of powerful operation and ensures a short digging cycle time. Increased hourly digging rate allows more work done by the end of the day.

Bucket digging force:
35.2 kN

Arm crowding force:
28.0 kN



Easy transportability

With an overall height of 2,530 mm, the machine is designed for easy transport.

Overall height:
2,530 mm



Energy conservation mode

The SK50P adapts S mode which enables 23% less fuel consumption compared with the previous model.

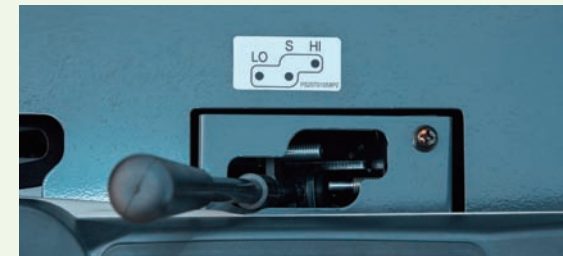

Powerful travel

The drawbar pulling force of 56.1 kN allows easy travel on marshy ground and grades. With this feature, the SK50P can travel smoothly across large plantations at a travel speed of up to 3.7 km/h.

Drawbar pulling force:
55.1 kN

Travel speed:
3.7 km/h



Plenty of lifting power

The heavier counterweight provides greater stability, with lifting power to spare.

Lifting power:
0.8 tons at 4.0 m

Wide working range

The working range has been increased to meet work site requirements. It enables the efficient digging of silt pits.

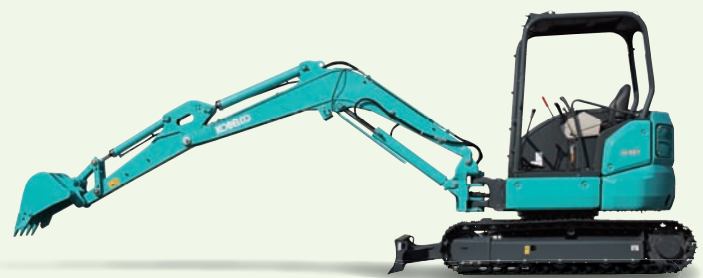

Max. digging reach:
5,980 mm

Short tail swing

The boom swing function enables the excavator to operate at the very edge of a road. The minimized tail overhang allows efficient work at narrow sites.

Tail overhang:
190 mm



The tail overhang is 196 mm, which is within 10% of the machine width complying with the Japanese definition of SR (Short Radius).

Travel Switch

The travel lever is fitted with a button for easy switching to H-Mode travel.



Unique dozer dumping soil without spilling

The large, curved dozer blade uniquely developed by KOBELCO does not spill soil. It makes it easy to construct paths for delivering palm.

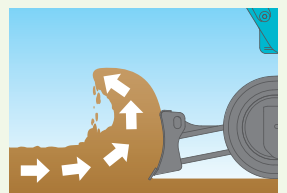

Comfortable Work Environment

COMFORT

Spacious work environment

The newly designed, rectangular cab is over 820 mm wide, with optimized control layout for comfortable, easy operation. A greater window area further improves visibility. A clear view is provided at the rear, and there's also more floor space, with a seat that slides further to ensure plenty of leg room.



Plenty of foot room

Generous space below facilitates pedal operation.



Travel pedals included as standard

SK50P comes equipped with travel pedals as standard equipment, thereby facilitating immediate escape from the marshy ground. A lever and foot pedal combination allows simultaneous operations.



Control panel

The monitor display panel is installed at an easy-to-read angle.



Work light

A work light has been installed to provide a clear view during nighttime operations.



Hour meter

The hour meter is on the wall low down to the right of the operator's seat. It can be checked while standing on the ground.



Easy Daily Maintenance

MAINTENANCE

Start-up checks are essential for safe and reliable machine operation. All start-up checks can be performed at ground level, with an easy-to-understand layout and cover design that simplify access and save time.

Easy access to component under the seat



Two-piece floor mats for easy washing



Hour meter

Easy access to engine compartment



High-grade fuel filter

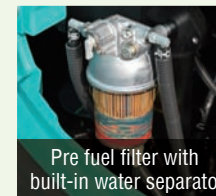

Pre fuel filter with built-in water separator



Air cleaner

Increasing the size of the fuel filter doubles the maintenance interval from 125 hours to 250 hours.

Radiator not readily clogged

The radiator now has a wavy fin design that does not readily become clogged. Making the engine produce its maximum performance.

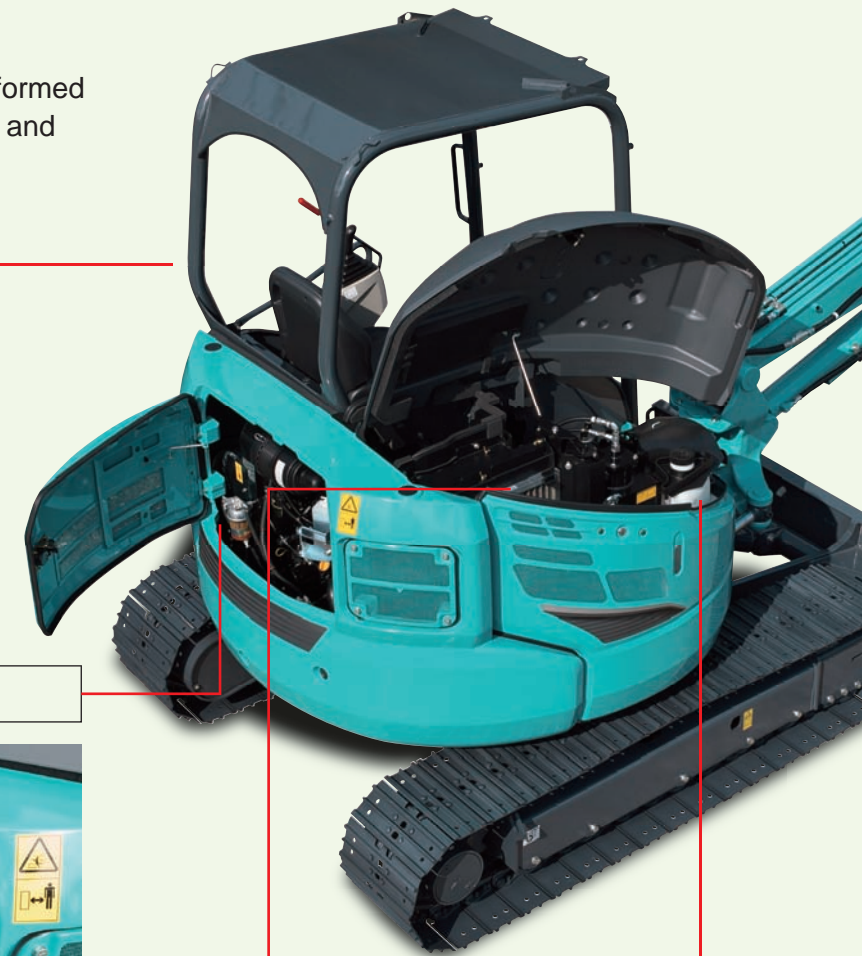

Large-capacity fuel tank

The 75-liter fuel tank enables extended, continuous operation.



Easy access to cooling unit

Concentrated equipment layout on the right deck makes the daily maintenance easier than ever.

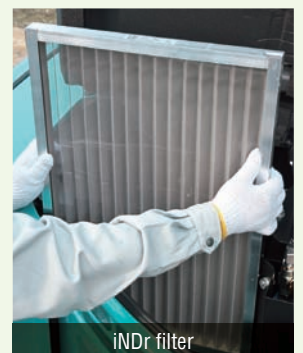
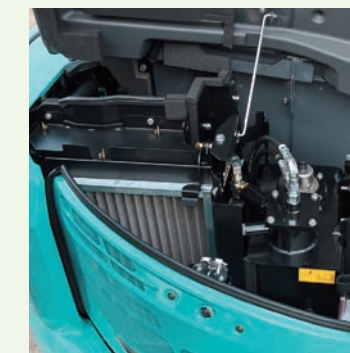

iNDr filter